

TECHNICAL SHEET

9.70 HEAVY DUTY RANGE

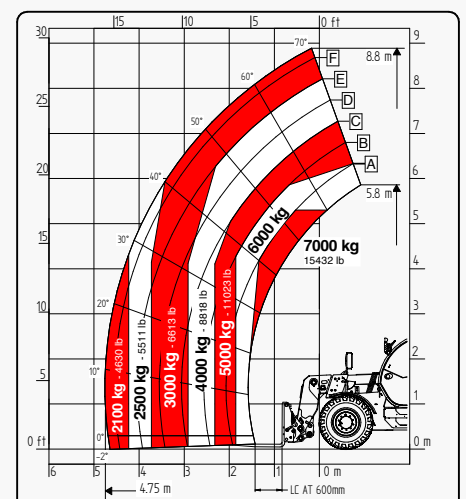

It brings to the attention of all potential customers, all recipients, and to the maximum extent possible, external interlocutors, that Faresin Industries S.p.A. adopts a general Disclaimer regarding the description of the technical and functional characteristics of its machineries, as well as the manner of their use, also with regard to their safety. The Disclaimer must be understood as having a general scope, and therefore Faresin Industries s.p.a. invites to know it, also by accessing the website: www.faresindustries.com

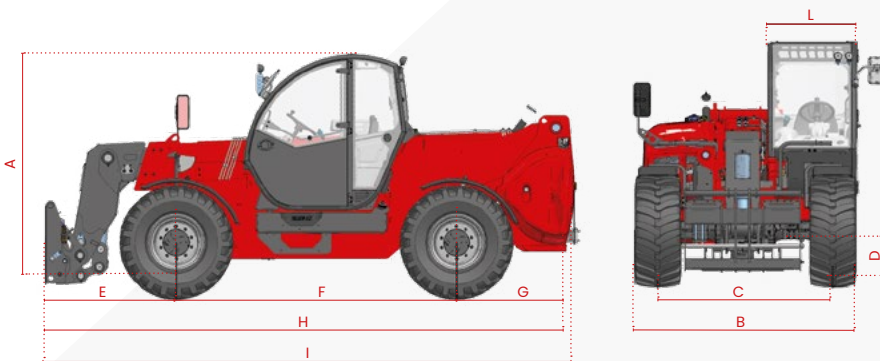

FARESIN.COM



9.70 HEAVY DUTY RANGE

TECHNICAL FEATURES

MODELS		9.70
DIMENSIONS		
[A] Height	mm	2550
[B] Width	mm	2334
[C] Gauge	mm	1840
[D] Ground clearance	mm	410
[E] Front overhang	mm	1373
[F] Pitch	mm	2950
[G] Rear overhang	mm	1265
[H] Length without tow hitch	mm	5556
[I] Length with tow hitch	mm	5628
[L] Cabin width	mm	960
WEIGHT		
Classic 74	kg	10700
HLS 74	kg	10900
VPSe 100	kg	11000

MODELS		9.70
DETAILS		
Number of extracting sections	nr	1
Max capacity	kg	7000
Max lifting height	m	8,8
Max horizontal boom extension	m	4,75
Boom extension at max height	m	0,2
Swinging Angle	°	149
TANK CAPACITY		
Hydraulic oil tank	l	150
Diesel tank	l	120
CONNECTION FOR EQUIPMENT		
FH HEAVY		●

NOTE: All dimensions defined on model with wheels 445/65 R22,5

CONFIGURATION	CLASSIC 74	HLS 74	VPSe 100
TRANSMISSION			
Hydrostatic	two mechanical gears	two mechanical gears	continuous variation
Speed	km/h	40	40
ENGINE STAGE V			
Builder	Deutz	Deutz	Deutz
Power	kW/hp	74,4/101	100/136
Aftertreatment system	DOC + DPF + SCR	DOC + DPF + SCR	DOC + DPF + SCR
Drawbar pull	daN	8500	10400
HYDRAULIC			
Pump type	gears pump	LS piston pump	LS piston pump
Hydraulic capacity	l/bar	120/230	180/250
TYRES			
445/65 R22,5	●	●	●
Turning radius	m	4,5	4,5
OTHER			
Joystick	mechanical-electro proportional	hydraulic-electro proportional	hydraulic-electro proportional
Quick coupling	○	○	●
Electro-proportional double acting rear hydraulic connection	○	○	○
Front and rear LED lights	○	○	○
Rear trailer lights socket	○	●	●
6 t fixed tow hook	○	●	●
Engine water pre-heating	○	○	○
Air conditioning	○	○	●
Regeneration valve in ascent	-	●	●
Floating boom	○	○	○
Boom suspension	○	○	○
Manual 6-way diverter	○	○	○
PEB (Boom Electric Socket)	○	○	○
Creeper	○	●	●
Front constant flow	○	○	○
Bucket mode	●	●	●
Pneumatic / hydraulic trailer brake	○	○	○
Frame lateral levelling ±10°	●	●	●

● Standard ○ Optional - Not available